

Model 73084, 73085, 73086, 73088

Terminal Jacks, Male Threads 6-32, 8-32, 10-32, Female Threads 6-32

Features

- Adapter provides an easy and quick banana jack connection by replacing the screw in a terminal strip or control panel.
- Allows a standard sheathed or unsheathed banana plug / patch cord to securely connect to a terminal strip.
- Helps to avoid accidental arc-over by eliminating the usage of alligator clips, or test probe "slip offs" during measurement applications.
- Perfect for use with model **73087** jumper test lead sets in *peer-checking system* test sequences.
- For more information, please visit our "**Articles**" section on nuclear applications at www.pomonaelectronics.com.



Materials

Banana Jack: Nickel-plated Brass
Insulation: Polypropylene V-2

Specifications

Voltage: 600 Vrms, Maximum voltage for *hands free use*.
For *CE compliance*, do not hold in hand when voltages exceed 33 Vrms / 70 Vdc

Current: 20 A

Operating Temperature: -10° C to +80° C (+14° F to 176° F)

Torque In/Lb.:
73084: 7
73085: 20
73086: 20
73088: 16

Dimensions



Model 73086, 10-32 Female Terminal Jack

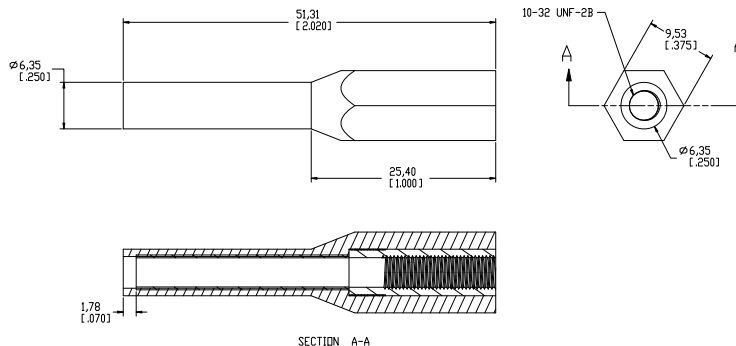

USA: Sales: 800-490-2361
 Technical Support: technicalsupport@pomonatest.com
 Fax: 425-446-5844

Europe: 31-(0) 40 2675 150 International: 425-446-5500

Where to Buy: www.pomonaelectronics.com

All dimensions are in inches. Tolerances (except noted): .xx = $\pm .02$ " (.51 mm), .xxx = $\pm .005$ " (.127 mm). All specifications are to the latest revisions. Specifications are subject to change without notice. Registered trademarks are the property of their respective companies.

Model 73084, 73085, 73086, 73088

Terminal Jacks, Male Threads 6-32, 8-32, 10-32, Female Threads 6-32



Model 73084, 6-32 Male Terminal Jack

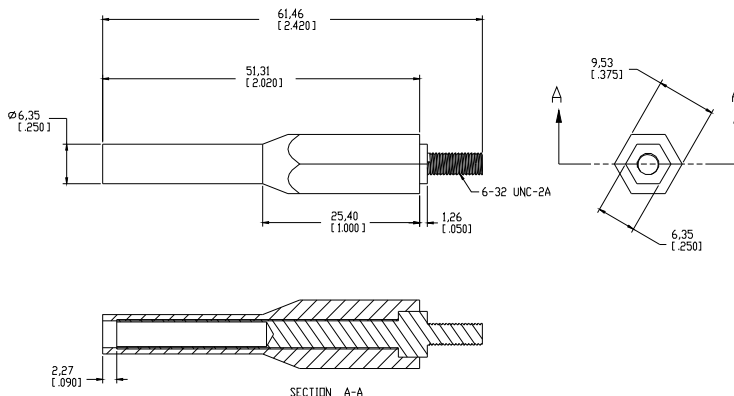

Model 73088, 8-32 Male Terminal Jack

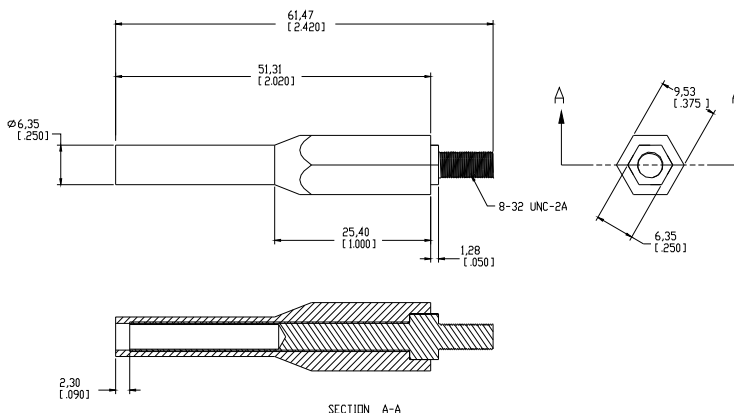

Model 73085, 10-32 Male Terminal Jack

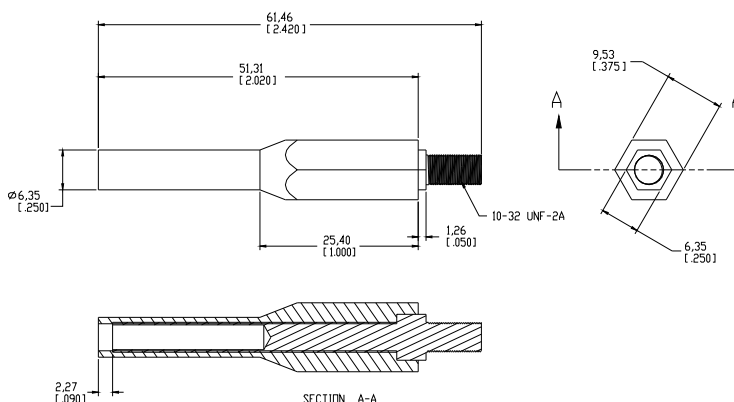

Ordering Information

Model: **73084, 73085, 73086, 73088**

Standard Colors: -0 Black, -2 Red, -4 Yellow, -6 Blue

Ordering Example: **73084-2**, (73084 terminal jack with Red insulation)

USA: Sales: 800-490-2361
 Technical Support: technicalsupport@pomonatest.com
 Fax: 425-446-5844

Europe: 31-(0) 40 2675 150 **International:** 425-446-5500

Where to Buy: www.pomonaelectronics.com

All dimensions are in inches. Tolerances (except noted): .xx = ±.02" (.51 mm), .xxx = ±.005" (.127 mm). All specifications are to the latest revisions. Specifications are subject to change without notice. Registered trademarks are the property of their respective companies.